



 **SPIETH**
Gymnastics

just for 



When it comes to your kids, only the best is good enough. Which is why we take such great care with our Just For kids products. At the design stage we benefit from our extensive experience as a developer of top sporting equipment. We only use materials that meet the highest quality standards and are ideal for use by young children. What's more, the quality of both raw materials and final products is stringently monitored. Together with our eye for detail and a craftsman's finish, this results in a unique product range.

The kids themselves just love our equipment, though this is for a host of other reasons! Such as the playful colour schemes and the opportunity to clamber, jump, hang and balance to their heart's content. Just For kids excels in designing products that challenge kids to get exercising over and over again.

But we have also thought about the teachers and supervisors of sports clubs, day-care centres, playgroups and primary schools. And we always focus on practicality and ease-of-use when developing our equipment. Just For kids equipment is space-saving and can be quickly set up and cleared away again. The equipment can be used in a multiplicity of ways and can be combined into ever new combinations. In addition to containing our entire product range, this catalogue gives you a few inspiring examples of these endless possibilities.

Interested? Then please don't hesitate to contact us for more information!



SPIETH Gymnastics GmbH

P.O. Box 53
 73774 Altbach, Germany
 Tel.: +49(0)7153 50 32 800
 Fax: +49(0)7153 50 32 811
 E-Mail: info@spieth-gymnastics.com
 Internet: www.spieth-gymnastics.com



SPIETH advises against modifying the equipment supplied. SPIETH cannot be held responsible for any damage in the case of unauthorized modifications. Such changes also invalidate the warranty. Equipment and mats have a limited lifespan, and materials are subject to wear. Please check regularly all parts subject to heavy use. Our general delivery and payment conditions apply. SPIETH reserves the exclusive right to modify or change its products at any time. This catalogue replaces any previous documentation. Copyright: SPIETH Gymnastics GmbH



PRODUCT OVERVIEW
Page 4 - 23



ACCESSORIES OVERVIEW
Page 24 - 28



TECHNICAL DETAILS
Page 29 - 31





CLIMBING ISLAND

Item 155534

The climbing island is very versatile, easy to adjust and quick to set up. It's very stable and practical without requiring floor mounts, and includes two foldable mats. Can be endlessly combined with other equipment and accessories, and requires just 2 m² of storage space.

- easily and compactly stored
- mobile and foldable
- main section is 216 cm high
- 2 wings are 125 cm high
- 228x216x96 cm when folded up

Various accessories can be found on page 24!





1



2



3



4



5



6



7



8



9

CLIMBING ISLAND

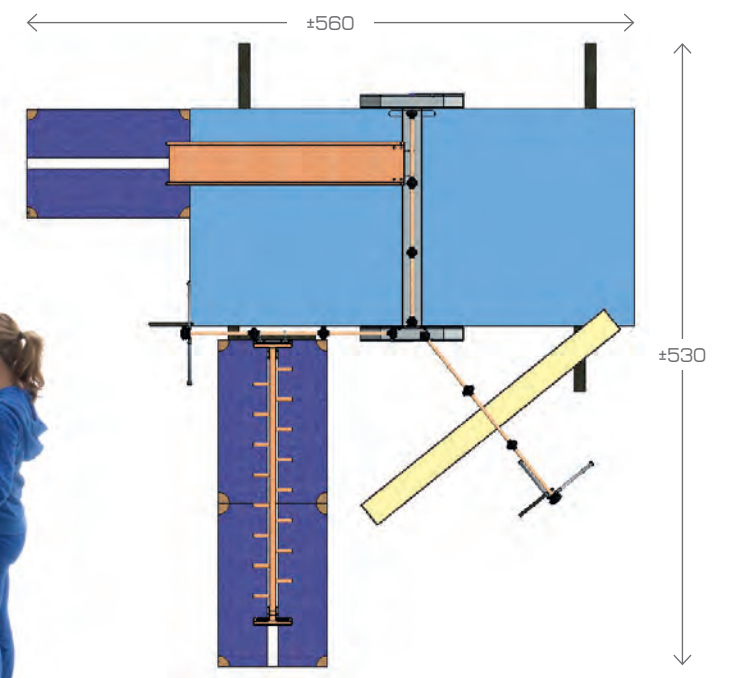



www.spieth.com

ID 1000000000



MULTIBOX®

Item 1408180 Multibox® Red, Item 1408181 Multibox® Blue

Item 1408185 Multibox® Red, filled, Item 1408186 Multibox® Blue, filled

Exercise unit and storage space in one: With ladder and sliding step-up or storage drawer. Multibox is easy to combine with other Just For kids equipment. It is mobile with an integrated transport system. Using connection bars and intermediate decks, a variety of exercise options are possible. Base of Multibox 108x80 cm, Height 107 cm, Deck for Multibox 89x80 cm, Height of step-up drawer 53 cm, Width of step-up drawer 59 cm. Available in red or blue.



INTERMEDIATE DECK

Item 1408160

With the 78x58 cm intermediate deck multiboxes can be quickly and easily connected to form a larger surface area. The deck section is fitted using 2 connection bars, self-clamping rubbers and velcro strips.

Intermediate decks can be fitted using short or long connection bars. The connection bars should be ordered separately.



SHORT CONNECTION BAR

Item 4170590

Diameter 35 mm, for intermediate deck



LONG CONNECTION BAR

Item 4170600

Diameter 35 mm, for two intermediate decks



CONNECTION BARS

Metal bar with locking mechanism for use with or without intermediate decks.



www.spieth.com
ID 100000000



MAT BOX
Item 1555915
Includes 16 Elements +
1 Dice



MAT SET 1
Item 1555904
Includes 6 elements



MAT SET 2
Item 1555908
Includes 2 elements



MAT SET 3
Item 1555909
Includes 4 elements



MAT BOX

Item 1555915

This rollable mat box includes various mat forms that can be combined in many different ways to create unique exercise options, even in small spaces. It includes a soft-padded solid base plate and four wheels. The sides of the mat box are also used as play mats and can be connected using velcro strips. All sections are covered with a soft and durable material that is hygienic and gentle on young skin. The complete mat and games set is compactly stored in the mat box to save space.

The complete mat box includes: 1 base plate 110x110 cm incl. 4 castors - 4 mats 100x80x10 cm, which also function as the sides of the box - 2 arches 60x30x15 cm - 3 cubes 80x30x30 cm - 2 semi-cylinders 80x30x30 cm - 2 corner pieces 60x60x30 cm - 2 trapezoids - 1 dice - velcro strips

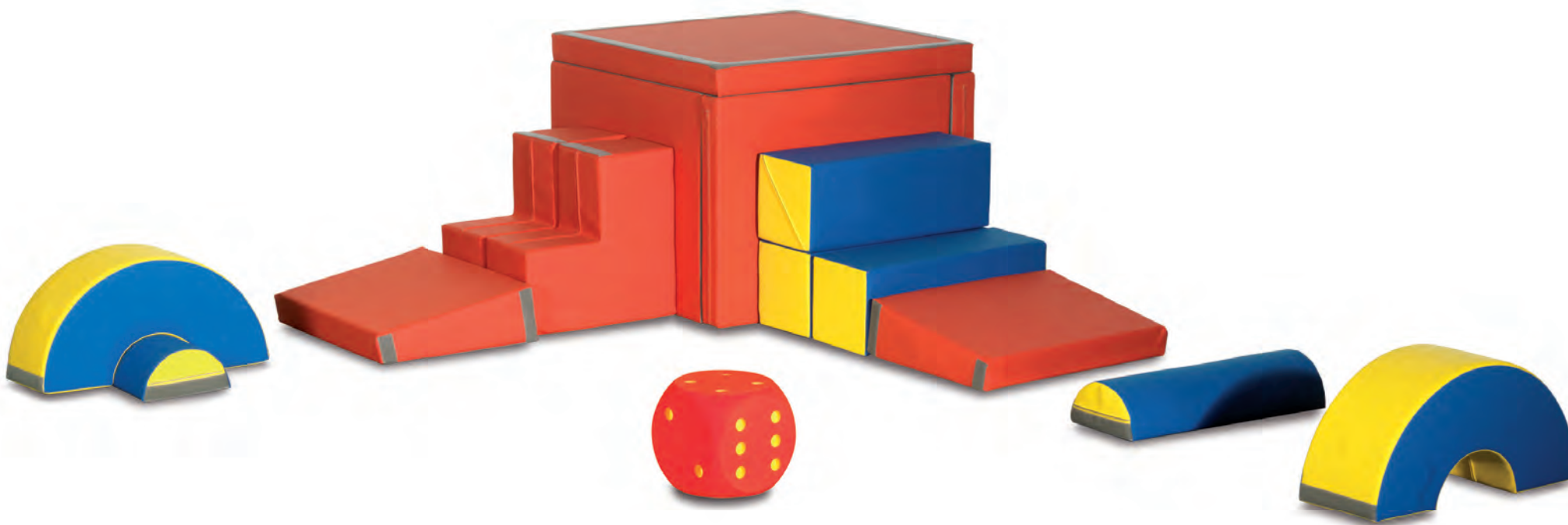



JUMPER

Item 1408254

Designed as a vault for children, Jumper boxes have many possible functions: Connecting bars can be attached using the openings in the box sides. Furthermore, the integrated platform means various heights are possible. Length 85 cm, width 75 cm, height 95 cm.

- box top is covered in durable leather
- soft and safe rubber on short sides
- made of wood with metal-reinforced openings
- pyramidal base for greater stability
- integrated transport system using castors
- integrated platform for multiple uses



JUMPER

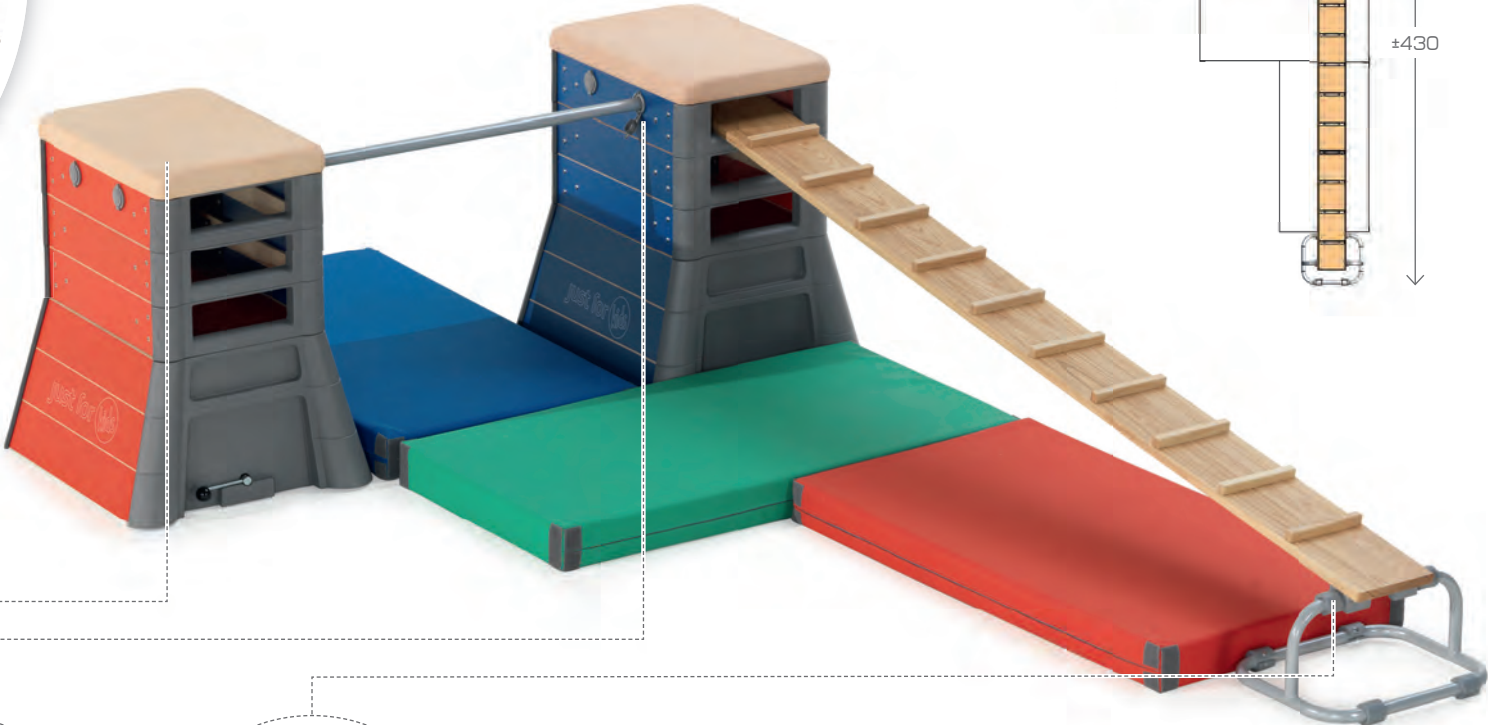
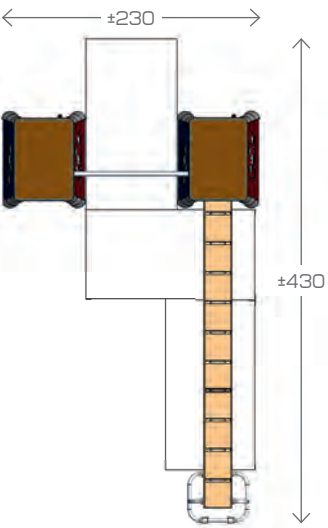

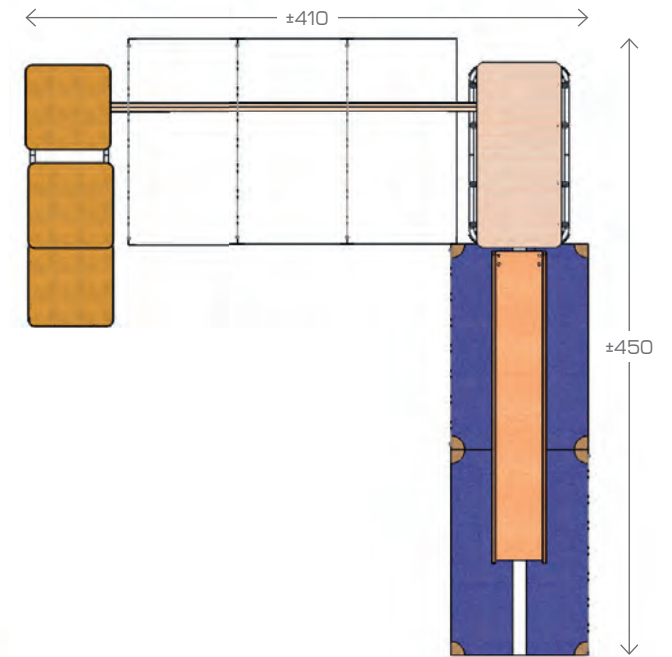

COMBIFRAME

Combiframes are available in various models. They are made of thin-walled metal tubing with rounded corners. This makes them lightweight, safe and easy to use. The combiframes can be stacked and used with other Just For Kids equipment, giving a wide variety of exercise options. The matching tops are made of solid wood or durable material with absorbent filling and are available in two sizes. They can be secured to other combiframes using the self-clamping rubbers.

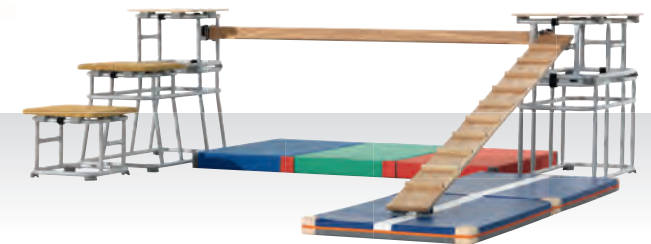

COMBIFRAME 4-IN-1



COMBIFRAME 4-IN-1

Item 1409294

Comprises two inwardly tapering steel frames, 1 wooden deck plank and 7 connectable mats that can be stored in the frame. The Combiframe can be combined with many other Just For kids products. It is made of thin-walled metal tubing with rounded corners. The Combiframe is lightweight and safe to use. Total height of Combiframe 85 cm, width between 57 cm and 90 cm.

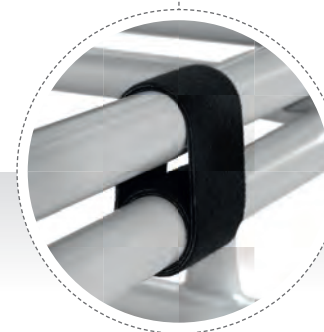



MINI-GYMNASTICS

Item 1403458

Square, space-optimized base frame including Just For kids modules mini-uneven bars, mini-horizontal bar, mini-parallel bars and mini-rings. Total area approx. 4 x 4 m. Supplied without mats.



MINI-HORIZONTAL BAR 'JUST FOR KIDS'

Item 1403424

Includes 2 stable base frames 200 cm long, 2 uprights for base frames with special clamps, 2 height-adjustable tubing including wooden parallel bar 160 cm long. Height adjustable in steps from 160 - 180 cm.



MINI-PARALLEL BARS 'JUST FOR KIDS'

Item 1403434

Includes 2 stable base frames 200 cm long, 4 uprights for base frames with special clamps, 4 low adjustable tubing including parallel bars 160 cm long. Height adjustable in steps from 85 - 125 cm.

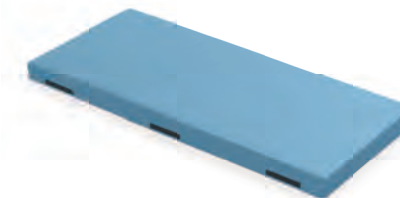

MAT FOR 'JUST FOR KIDS' EQUIPMENT

Item 1403464

With bisonyl and zipper, 300 x 135 x 18 cm, blue



MINI-UNEVEN BARS 'JUST FOR KIDS'

Item 1403454

Includes 2 stable base frames 200 cm long, 4 uprights for base frames with special clamps, 2 low and 2 high adjustable tubing including parallel bars 160 cm long. Height adjustable in steps from 85 - 125 cm and from 160 - 180 cm.



DOUBLE REBOUNDER 'JUST FOR KIDS'

Item 1403414

Double Rebounder; includes base frame with height-adjustable tubing with elastic cord, protective padding and bar. Ideal as a training aid for practicing the swing on the uneven bars or horizontal bar and for strengthening the abdominal and back muscles.



MINI-STILL RING FRAME 'JUST FOR KIDS'

Item 1403444

Includes 2 stable base frames 200 cm long, 2 uprights for base frames with special clamps, 2 extra high adjustable tubing including straps and rings. Height adjustable in steps from 195 - 220 cm.



TIPU

Item 1555920

6 colourful stools that can be used clamped into each other, creating lots of possibilities either individually or combined. They can be used to sit on, balancing, running around, as a demarcation or just for playing with. Sold as a set or separately, a stool is 40 cm high and weighs 3 kg.



GYMNASTIC BUCK

Item 1407024

For school sports to teach vaulting. The gymnastic buck is 60 cm long and is height adjustable 90–125 cm. The body is covered with real leather. Integrated castors make the gymnastic buck quick and easy to set up.



MINI VAULTING TABLE

Item 1407198

The „Mini Vaulting Table“ is a small version of the vaulting table known from artistic gymnastics. These smaller devices enable children to vault safely. They learn to vault without fear: The 85–125 cm height adjustment means the Mini Vaulting Table can be set to different ages and levels of difficulty.



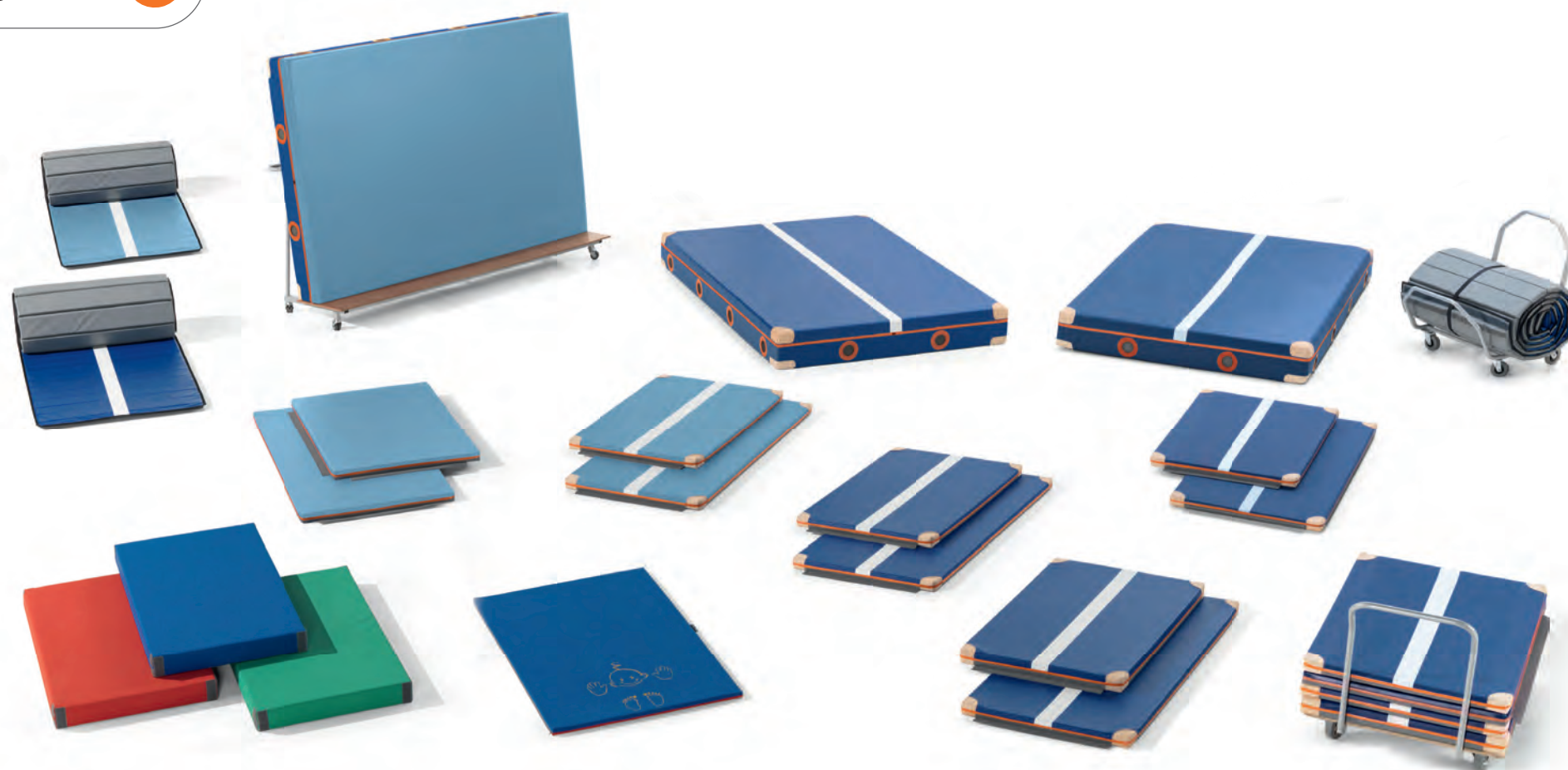

MATS OVERVIEW

A wide range of mats are available that can be used in many different ways. From nursery children learning their first forward rolls, to safe landings from greater heights for older kids, the range offers a wide array of options. The mats ensure a safe environment for kids to learn their moves. The mats are lightweight and easy to stack.

- flame retardant
- washable, hygienic
- easy to transport with integrated handy grips
- 2-sided linking

See page 25 for technical details on the individual products, such as length, height and weight.



BOXES OVERVIEW

Boxes are an essential part of school sports equipment for learning different moves. Our products offer a variety of combinations in addition to the classical use as a vault box. This opens up all sorts of new exercise options. The boxes are suitable for both nursery age and school sports for older kids.

- metal-reinforced box elements
- highly stable due to adjustable lower section
- box tops of real leather (Multibox has artificial leather)
- integrated castors for easy transport

Further information about multiboxes can be found on page 8 and Jumper boxes on page 12. All other technical details are on page 29.



www.spieth.com

ID 1000000000



BENCHES OVERVIEW

The bench is suitable for sports training for all ages and is a must for every nursery or school. Our benches are distinguished primarily by their ease of use and high stability. The castors mean the benches can be set up quickly. Being made of not only wood but also metal, the benches are particularly stable and unlikely to tip over.

- castors for easy transport
- very stable because of metal reinforcement
- can be hooked in the vaulting box or the Jumper
- uses wood from FSC-certified suppliers

Further technical details can be found on page 29!



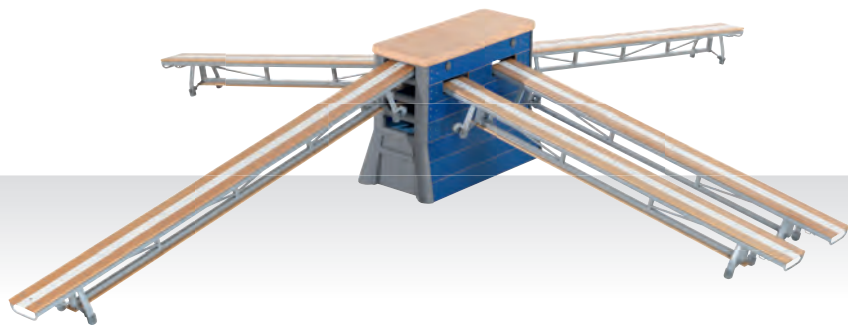

VAULTING BOXES

Item 1408124

with lateral openings in mid-section

Item 1408134

with lateral openings in top section





BALANCING BAR WITH
COUPLINGS
Item 1490364
290x10x7 cm



BAR
Item 1421004
195x4x8 cm
Metal, with securing clamps.



ZIG-ZAG LADDER
Item 1495264
290x34x10 cm
Stable uprights with 16 rungs.



CHICKEN LADDER
Item 1495270
290x24x10 cm
With 10 rungs.



WOODEN SLIDE
Item 1495254
250x40x12 cm
With raised edges.
Width of slide chute 34 cm.



FLEXIBLE PLANK
Item 1495920
290x8x24 cm
Self-clamping rubbers and covered
hook-in bracket



BENCH PLANK
Item 1490930
290x8x24 cm
Self-clamping rubbers in the
middle and at the ends.



NARROW LADDER
Item 1495174
290x44x9 cm
With 13 rungs.



WIDE LADDER
Item 1495164
290x66x9 cm
With 8 rungs.



BALANCING BAR
Item 1005056
220x24x12cm
Also fits nursery bench, item
1005059.



GYMNASTIC BENCH 360 CM
Item 1388501 incl. 7 cm bars
360x26x32 cm
Steel frame, 2 wheels, 4 protective
rubber feet, 3 interchangeable
seat slats. Walking bars of 7 cm
width at bottom.



GYMNASTIC BENCH 300 CM
Item 1388506 incl. 7 cm bars
300x26x32 cm
Steel frame, 2 wheels, 4 protective
rubber feet, 3 interchangeable
seat slats. Walking bars of 7 cm
width at bottom.



NURSERY BENCH
Item 1005059 250 cm
Item 1005058 290 cm
250x24x30 cm
Sturdy wooden bench with
metal feet and wheels.



GYMNASTIC BUCK
Item 1407024
Stable and easy to adjust from 90
to 125 cm.



MINI VAULTING TABLE
Item 1407198
Learn to vault without fear.
Height adjustable from 85 to
135 cm. Size of deck plank
90x72 cm.

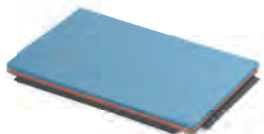

PRACTICE MAT BASIC
Item 1570020
150x100x6 cm
Connectable on 4 sides, lightweight filling.

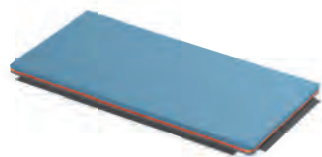

PRACTICE MAT BASIC
Item 1571020
200x100x6 cm
Connectable on 4 sides, lightweight filling.

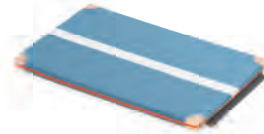

PRACTICE MAT,
LIGHTWEIGHT BISONYL
Item 1570040
150x100x6 cm
Connectable on 2 sides, lightweight filling, 2 handy grips, leather corners.

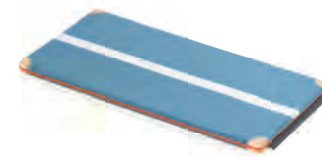

PRACTICE MAT,
LIGHTWEIGHT BISONYL
Item 1571040
200x100x6 cm
Connectable on 2 sides, lightweight filling, 2 handy grips, leather corners.

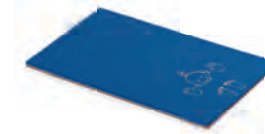

PLAYING MAT INFANT
Item 1550580
150x100x3 cm.



PRACTICE MAT, BISONYL
Item 1570042
150x100x6 cm
Connectable on 2 sides, sandwich filling, leather corners.



PRACTICE MAT, BISONYL
Item 1571042
200x100x6 cm
Connectable on 2 sides, sandwich filling, leather corners.



SUPER 8 PRACTICE MAT
Item 1570142
150x100x8 cm
8 cm sandwich filling and connectable on 2 sides, with marking and leather corners.



SUPER 8 PRACTICE MAT
Item 1571142
250x100x8 cm
8 cm sandwich filling and connectable on 2 sides, with marking and leather corners.

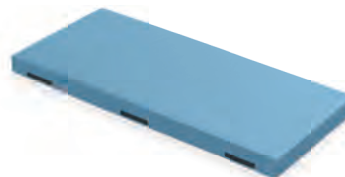

MAT FOR 'JUST FOR KIDS'
EQUIPMENT
Item 1403464
300x135x18 cm
Bisonyl and zipper, blue



TUMBLING MAT, BISONYL
Item 1573010
600x120x4 cm
For rolling and jumping, easy to roll up, lightweight, connectable.



TUMBLING MAT, BISONYL
Item 1573011
600x120x4 cm
For rolling and jumping, easy to roll up, sandwich filling, connectable.

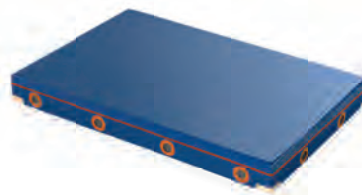

LANDING MAT BASIC
Item 1572000
300x200x30 cm
Soft filling 18 kg/m³, 4 leather corners, 12 handy grips.

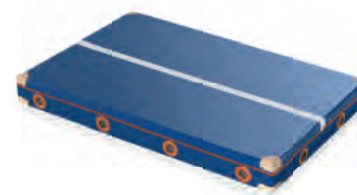

LANDING MAT BISONYL
Art. 1572011
300x200x30 cm
PU filling 30 kg/m³, 8 leather corners, 12 handy grips.

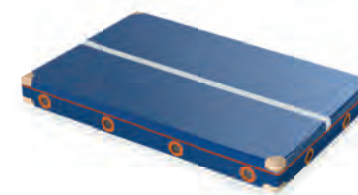

LANDING MAT, BISONYL
Item 1572013
300x200x30 cm
Sandwich filling, 8 leather corners, 12 handy grips.



MINI-SPRINGBOARD
"JUNIOR"

Item 1411754

Original Reuther; for body weight of max. 40 kg.



SPRINGBOARD, PADDED

Item 1411764

120 X 60 cm
Original Reuther; for body weight of max. 80 kg.



MINI TRAMPOLINE

Item 1411811

Dimensions adapted to gym benches.
Height adjustable front 30-39 cm, rear 39-53 cm.
Can also be used horizontally (39 cm).



MINI-GYMNASTICS

Item 1403458

Total surface area approx. 400x400 cm
Base frame with mini-parallel bars, mini-horizontal bar, mini-uneven bars and mini-ring mount. Supplied without mats.



COMBIFRAME 4-IN-1

Item 1409294

Complete with 7 mats and round deck plank, frame width 57-90 cm and height stacked about 85 cm.



TIPU

Item 1555920

40 cm
6 stable stools, easy to use, can be assembled into a bench. 18 kg (6x3 kg).



TRANSPORT TROLLEY

Item 1522084

For combiframes, etc.



CLIMBING ISLAND

Item 1555534

A games room or gym in 3 minutes. With integrated mats.
Only 2 m² storage space required.



EXERCISE FRAME

Item 1490164

44x30x35 cm
Exercise frame usable on three sides. Height adjustable to 30, 35 and 40 cm.



COMBIFRAME, SHORT

Item 1409214

57x57x44 cm
Weight 6 kg.



COMBIFRAME, LONG

Item 1409204

130x57x44 cm
Weight 13 kg.



COMBIFRAME, PYRAMIDAL

Item 1409244

130x80/57x74 cm
Made of sturdy and thin-walled metal tubing (ø 35x1, 5 mm) that does not bend. Weight 18 kg.



VAULT DECK COMBIFRAME, SHORT

Item 1409260

63x63 cm

Wooden board with padding and artificial leather; with self-clamping rubbers for secure mounting to short combiframe and combiframe 4-in-1.



VAULT DECK COMBIFRAME, LONG

Item 1409280

136x63 cm

Wooden board with padding and artificial leather; with self-clamping rubbers for secure mounting to long and pyramide-shaped combiframe.



JUMPER

Item 1408254

79x72x45 cm

Multifunctional smaller boxes with pyramid-shaped base and integrated transport platform with castors, easy to roll. Mounting openings on two sides of the boxes and can be combined with connection bars. Very stable in accordance with NEN-EN 1176 and 916, made of wood with FSC label.



VAULTING BOXES WITH LATERAL OPENINGS IN MID-SECTION

Item 1408124

147x74x110 cm

Multifunctional boxes with pyramid-shaped base and integrated transport platform with castors, easy to roll. Mounting openings on all sides of the boxes and can be combined with connection bars. Very stable in accordance with NEN-EN 1176 and 916, made of wood with FSC label.



VAULTING BOX BASIC

Item 1408114

147x74x110 cm

Multifunctional boxes with pyramid-shaped base and integrated transport platform with castors, easy to roll. Mounting openings on two sides of the boxes and can be combined with connection bars. Very stable in accordance with NEN-EN 1176 and 916, made of wood with FSC label.



VAULTING BOXES WITH LATERAL OPENINGS IN TOP SECTION

Item 1408134

147x74x110 cm

Multifunctional boxes with pyramid-shaped base and integrated transport platform with castors, to roll. Mounting openings on all sides. Very stable in accordance with NEN-EN 1176 and 916, made of wood with FSC label.



INTERMEDIATE DECK FOR VAULTING BOXES

Item 1408223

137x55 cm

For expanding the surface of the boxes using connection bars. See page 28.



INTERMEDIATE DECK FOR MULTIBOX®

Item 1408160

79x58 cm

With self-clamping rubbers for mounting on connection bars. See page 28.



MULTIBOX® FILLED
Item 1408185 Multibox® Red, filled,
Item 1408186 Multibox® Blue, filled
 108x80x107 cm

- 10 Frisbee red, rubber
- 10 Frisbee yellow, rubber
- 3 Ring set, ten-part
- 30 Shaker Tube
- 2 Shape set, soft
- 1 Ball pump
- 4 Oball 19 cm
- 1 Inflatable dice, 120 cm
- 1 Inflatable ball, 120 cm
- 3 Round storage container 35x45 cm
- 30 Coxi-Bola for 1 player
- 1 Inflatable tunnel
- 15 Mikido
- 4 Catch loop
- 4 Elastic band with fabric
- 15 Kids' orange vest, 4-6 years
- 15 Kids' yellow vest, 4-6 years

Subject to change

- 7 Flying fish, green
- 7 Flying fish, yellow
- 8 Flying fish, red
- 8 Flying fish, blue
- 10 Frisbee blue, rubber



MULTIBOX®
Item 1408180 Multibox® Red, Item 1408181 Multibox® Blue
 108x80x107 cm



SHORT CONNECTION BAR
Item 4170590
 Accessories for vaulting boxes and Multibox®



LONG CONNECTION BAR
Item 4170600
 Accessories for vaulting boxes and Multibox®



MAT BOX
Item 1555915
 Compact storage for complete games set, rollable.



MAT SET 1
Item 1555904
 Includes 6 elements.



MAT SET 2
Item 1555908
 Includes 2 elements, and velcro strips.



MAT SET 3
Item 1555909
 Includes 4 elements, and velcro strips.

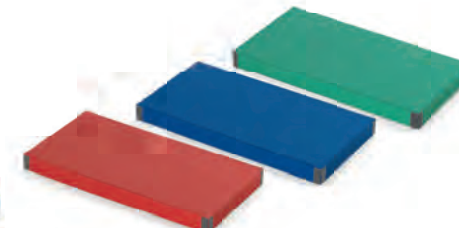

PLAYING MAT,
Item 4064010 Playing mat, blue
Item 4064011 Playing mat, red
Item 4064012 Playing mat, green
 150x80x12 cm
 Soft kids playing mat for 2-12 age range. Washable, lightweight, soft and gentle on young skin.

Item	Short description	Net weight (kg)	Gross weight (kg)	Number of packages	Dimensions (L x W x H metres)			Transport Volumen m ³	TÜV GS	FSC
					L	B	H			
1005056	Balancing bar	7	8	1	2,22	0,28	0,13	0,081		•
1005058	Nursery bench 290 cm	22	23	1	2,95	0,25	0,31	0,229		•
1005059	Nursery bench 250 cm	20	21	1	2,51	0,25	0,30	0,188		•
1388501	Gymnastic bench 360 cm	44	45	1	3,65	0,27	0,32	0,315	•	•
1388506	Gymnastic bench 300 cm	41	42	1	3,05	0,27	0,32	0,264	•	•
1403458	Mini-Gymnastics	260	270	1 pallet	2,00	0,90	1,20	2,160		
1403464	Mat "Just for Kids"	30	33	1	3,00	1,35	0,18	0,729		
1407024	Gymnastic buck	31	53	1 pallet	1,25	0,80	1,06	1,060		
1407198	Mini Vaulting Table	45,5	59	1 pallet	1,30	1,07	1,34	1,864		
1408114	Vaulting box Basic	141	158	1 pallet	1,48	0,74	1,10	1,200	•	•
1408124	Vaulting boxes with lateral openings in mid-section	141	158	1 pallet	1,48	0,74	1,10	1,200	•	•
1408134	Vaulting boxes with lateral openings in top section	141	158	1 pallet	1,48	0,74	1,10	1,200	•	•
1408160	Intermediate deck for Multibox®	11	11	1	0,79	0,58	0,13	0,060		
1408180	Multibox® red	126	150	1 pallet	1,20	1,00	1,30	1,560	•	•
1408181	Multibox® blue	126	150	1 pallet	1,20	1,00	1,30	1,560	•	•
1408185	Multibox® red, filled	140	164	1 pallet	1,20	1,00	1,60	1,920		•
1408186	Multibox® blue, filled	140	164	1 pallet	1,20	1,00	1,60	1,920		•
1408223	Intermediate deck for vaulting boxes	15	15	1	1,37	0,55	0,14	0,105		
1408254	Jumper	89	104	1 pallet	1,20	0,80	1,00	0,960	•	•
1409204	Combiframe, long	15	28,5	1 pallet	1,32	0,58	0,45	0,345		
1409214	Combiframe, short	8	10	1	0,58	0,58	0,45	0,151		
1409244	Combiframe, pyramidal	21,4	35	1 pallet	1,32	0,74	0,75	0,733		
1409260	Vault deck combiframe, short	8	8	1	0,63	0,63	0,10	0,038		
1409280	Vault deck combiframe, long	16	16	1	1,37	0,63	0,10	0,082		

Item	Short description	Net weight (kg)	Gross weight (kg)	Number of packages	Dimensions (L x W x H metres)			Transport volume m ³	TÜV GS	FSC
					L	W	H			
1409294	Combiframe 4-in-1	41,5	55	1 pallet	1,20	1,20	1,02	1,469		
1411754	Mini-springboard "Junior"	13	15	1	1,03	0,23	0,58	0,137		
1411764	Springboard, padded	23	25	1	1,25	0,25	0,65	0,203		
1411811	Mini trampoline	30	32	1	1,20	1,18	0,10	0,142		
1421004	Bar	5	5	1	2,07	0,16	0,08	0,026		
1490164	Exercise frame	5	5	1	0,55	0,47	0,29	0,075		
1490364	Balancing bar with couplings	14	15	1	2,91	0,13	0,09	0,034		•
1490930	Bench plank	14	15	1	2,92	0,25	0,09	0,066		•
1495164	Wide ladder	10	11	1	2,90	0,67	0,09	0,175		•
1495174	Narrow ladder	12	13	1	2,95	0,45	0,12	0,159		•
1495254	Wooden slide	17	18	1	2,52	0,41	0,15	0,155		•
1495264	Zig-zag ladder	12	13	1	2,92	0,37	0,11	0,119		•
1495270	Chicken ladder	15	16	1	2,91	0,25	0,11	0,080		•
1495320	Flexible plank	17	18	1	2,90	0,30	0,10	0,087		•
1522084	Transport trolley	1	1	1	0,75	0,25	0,10	0,019		
1550580	Playing mat infant	8	8	1	1,50	1,00	0,03	0,045		
1555534	Climbing island	192	195	1	2,30	0,96	2,20	4,858	•	
1555904	Mat set 1	10,5	24	1 pallet	0,80	0,60	1,70	0,816		
1555908	Mat set 2	8	10	1	0,80	0,60	0,70	0,336		
1555909	Mat set 3	16	31	1 pallet	1,20	0,80	1,60	1,536		
1555915	Mat box	57	82	1 pallet	1,10	1,30	1,45	2,074	•	
1555920	Tipu (set of 6)	18	27	1 pallet	0,60	0,84	1,00	0,504		
1570020	Practice mat Basic	5	5	1	1,50	1,00	0,07	0,105		
1570040	Tumbling mat, lightweight bisonyl	5	5	1	1,50	1,00	0,06	0,090		

Item	Short description	Net weight (kg)	Gross weight (kg)	Number of packages	Dimensions (L x W x H metres)			Transport volume m ³	TÜV GS	FSC
					L	W	H			
1570042	Practice mat, bisonyl	10	10	1	1,50	1,00	0,06	0,090		
1570142	Super 8 practice mat	9	10	1	1,50	1,00	0,08	0,120		
1571020	Practice mat Basic	7	7	1	2,00	1,00	0,06	0,120		
1571040	Tumbling mat, lightweight bisonyl	7	7	1	2,00	1,00	0,06	0,120		
1571042	Practice mat, bisonyl	13	13	1	2,00	1,00	0,06	0,120		
1571142	Super 8 practice mat	15	15	1	2,00	1,00	0,08	0,160		
1572000	Landing mat Basic	45	46	1	3,00	2,00	0,30	1,800		
1572011	Landing mat, bisonyl	64	65	1	3,00	2,00	0,30	1,800		
1572013	Landing mat, bisonyl	64	65	1	3,00	2,00	0,30	1,800		
1573010	Tumbling mat, bisonyl	26	26	1	0,75	1,25	0,75	0,703		
1573011	Tumbling mat, bisonyl	40	40	1	0,75	1,25	0,75	0,703		
4064010	Playing mat, blue	3	3	1	1,50	0,80	0,12	0,144		
4064011	Playing mat, red	3	3	1	1,50	0,80	0,12	0,144		
4064012	Playing mat, green	3	3	1	1,50	0,80	0,12	0,144		
4170590	Short connection bar	2	2	1	0,90	0,04	0,04	0,001		
4170600	Long connection bar	4	4	1	1,45	0,04	0,04	0,002		



SPIETH Gymnastics GmbH

P.O. Box 53

73774 Altbach, Germany

Tel.: +49(0)7153 50 32 800

Fax: +49(0)7153 50 32 811

E-Mail: info@spieth-gymnastics.com

Internet: www.spieth-gymnastics.com

just for kids